

GP2Y3A002K0F

Wide angle Distance Measuring Sensor Unit

Measuring distance: 20 to 150 cm
5 Analog outputs type



■ Description

GP2Y3A002K0F is a distance measuring sensor unit, composed of an integrated combination of PSD (position sensitive detector), 5-IREDs (infrared emitting diode) and signal processing circuit.

The variety of the reflectivity of the object, the environmental temperature and the operating duration are not influenced easily to the distance detection because of adopting the triangulation method.

This device uses 5 infrared beams for wide range (field of view) detection. This device outputs the 5 voltages corresponding to the each distance detection.

■ Features

1. Middle range type
Measuring distance range : 20 to 150 cm
2. 5 Analog outputs type
3. Package size : 40×20×18 mm
4. Consumption current : Typ. 30 mA
5. Supply voltage : 4.5 to 5.5 V
6. Detection angle : 25°

■ Agency approvals/Compliance

1. Compliant with RoHS directive (2002/95/EC)

■ Applications

1. Robot cleaner
2. Vending machine
3. ATM/CD
4. Fun heater
5. Amusement equipment
(Robot, Arcade game machine)

Notice The content of data sheet is subject to change without prior notice.

In the absence of confirmation by device specification sheets, SHARP takes no responsibility for any defects that may occur in equipment using any SHARP devices shown in catalogs, data books, etc. Contact SHARP in order to obtain the latest device specification sheets before using any SHARP device.

Sheet No.: E4-A01301EN

Date Dec.01.2006

©SHARP Corporation

Block diagram

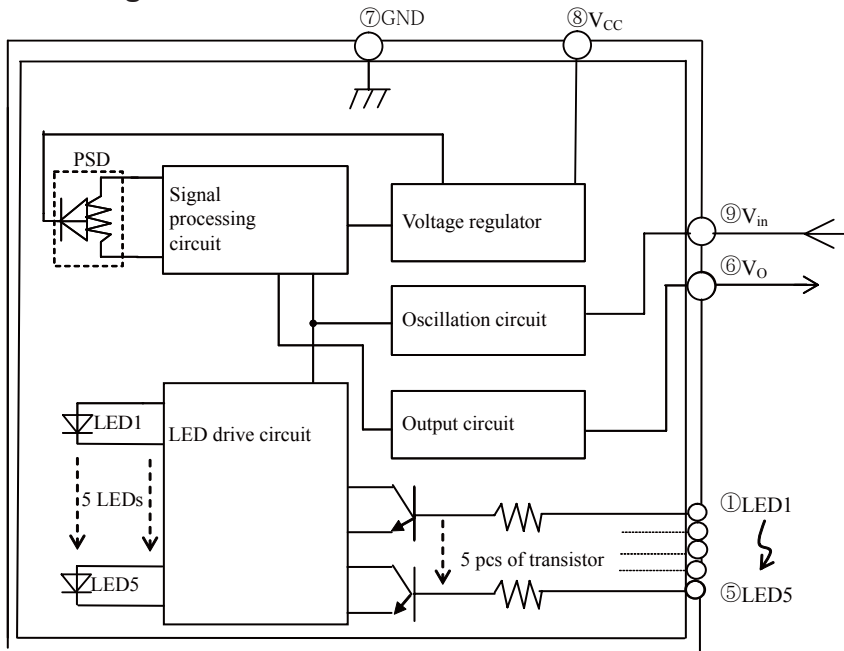

Outline Dimensions

(Unit : mm)

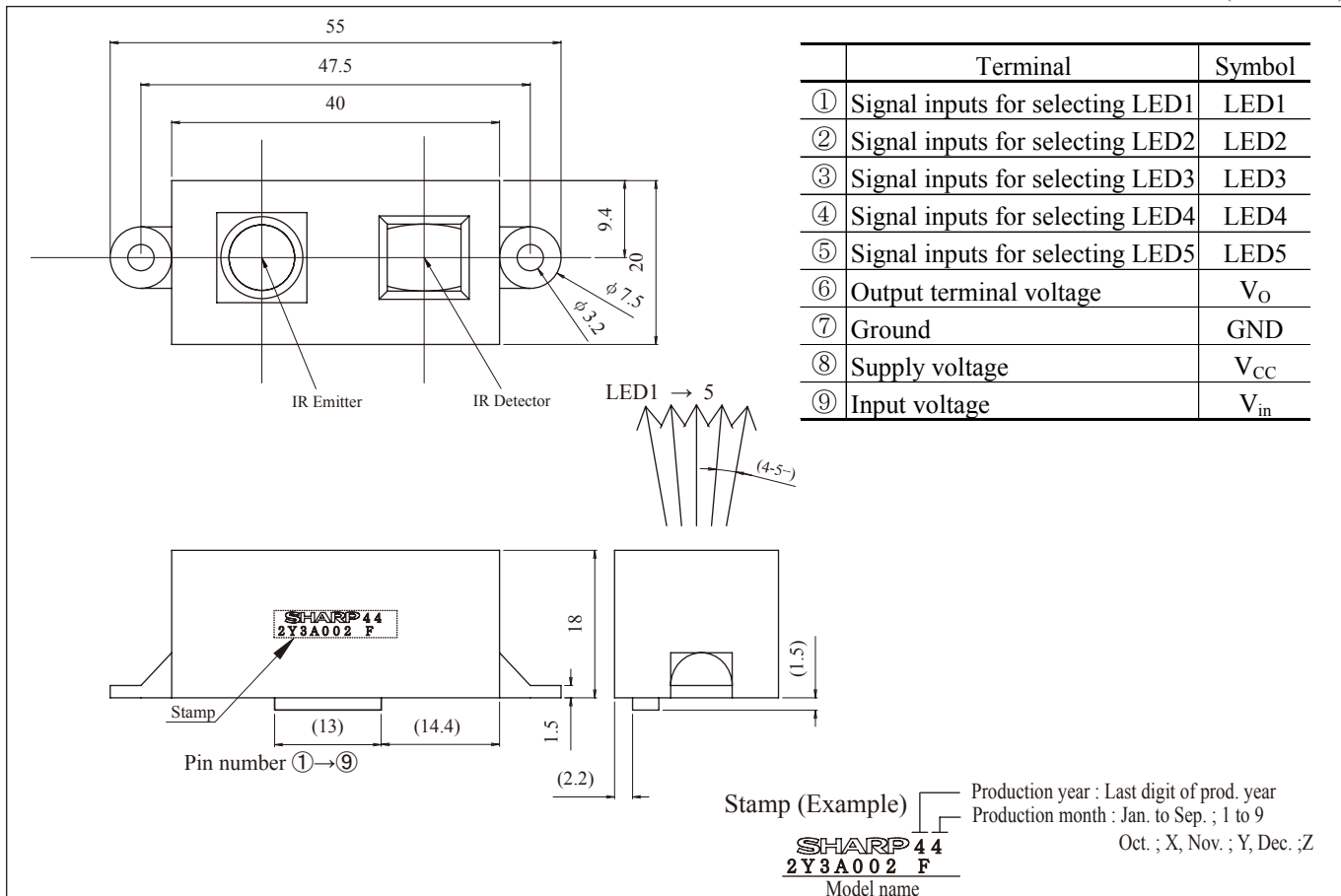

Note 1. Unspecified tolerances shall be ± 0.3 mm.

Note 2. The connector is made by Molex and its part number is 53047-0910.

Note 3. The dimensions in parenthesis are shown for reference.

Product mass : approx. 8.2g

■ Absolute Maximum Ratings (Ta=25°C, Vcc=5V)

| Parameter | Symbol | Rating | Unit |
|-------------------------|--------------------------------|------------------------------|------|
| Supply voltage | V _{CC} | -0.3 to +7 | V |
| Output terminal voltage | V _O | -0.3 to V _{CC} +0.3 | V |
| Input voltage | V _{in} H/L LED H/L | -0.3 to V _{CC} +0.3 | V |
| Operating temperature | T _{opr} | -10 to +60 | °C |
| Storage temperature | T _{stg} | -40 to +70 | °C |

■ Electro-optical Characteristics (Ta=25°C, Vcc=5V)

| Parameter | Symbol | Conditions | MIN. | TYP. | MAX. | Unit |
|-----------------------------|------------------|--|------|------|------|------|
| Average supply current | I _{CC} | | — | 30 | 50 | mA |
| Distance measuring range | ΔL | (Note 1) | 20 | — | 150 | cm |
| Output voltage | V _O | L = 20cm (Note 1) | 2.0 | 2.3 | 2.6 | V |
| Output voltage differential | ΔV _O | Output voltage difference between L=20cm and L=80cm (Note 1) | 1.3 | 1.6 | 1.9 | V |
| Input voltage | V _{inH} | Input voltage for operating distance measuring sensor | 4.5 | — | — | V |
| | V _{inL} | Input voltage for turning off distance measuring sensor | — | — | 0.3 | V |
| | LED H | Input voltage for turning LED on | 4.5 | — | — | V |
| | LED L | Input voltage for turning LED off | — | — | 0.5 | V |

* L : Distance to reflective object

Note 1 : Using reflective object : White paper (Made by Kodak Co., Ltd. gray cards R-27·white face, reflectance; 90%)

■ Recommended operating conditions

| Parameter | Symbol | Conditions | Rating | Unit |
|----------------|-----------------|------------|------------|------|
| Supply voltage | V _{CC} | | 4.5 to 5.5 | V |

Fig. 1 Timing chart

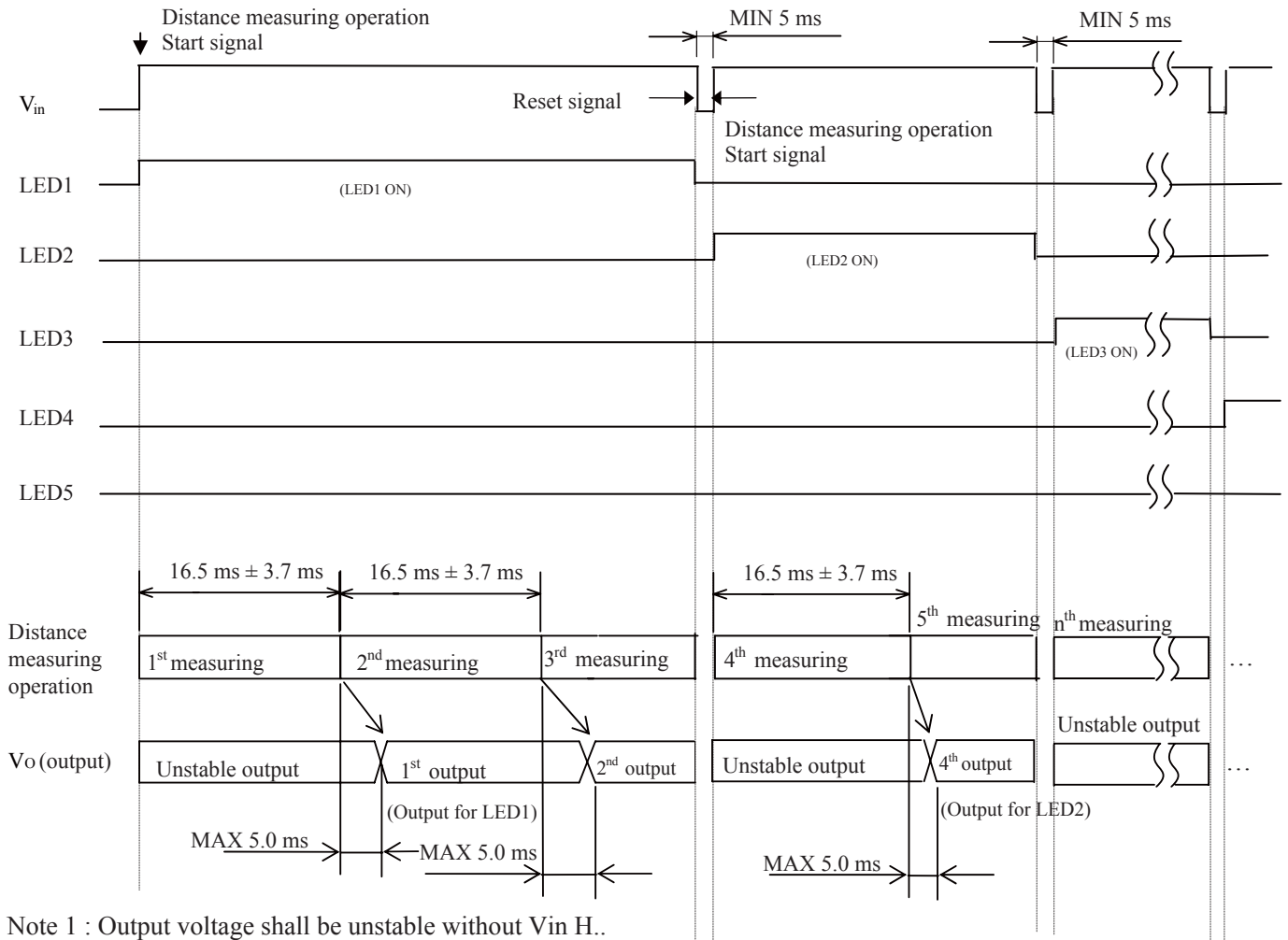

Note 1 : Output voltage shall be unstable without V_{in} H..

Note 2 : Please don't turn on more than two LEDs at the same time.

Fig. 2 Example of distance measuring characteristics (output)

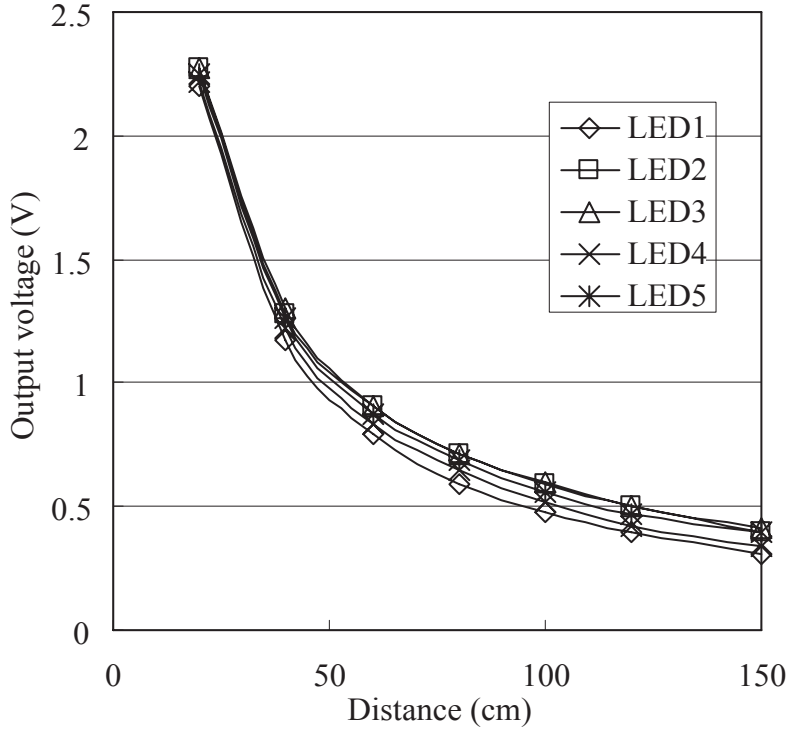

■ **Notes**

● **Advice for the optics**

- The lens of this device needs to be kept clean. There are cases that dust, water or oil and so on deteriorate the characteristics of this device. Please consider in actual application.
- Please don't do washing. Washing may deteriorate the characteristics of optical system and so on. Please confirm resistance to chemicals under the actual usage since this product has not been designed against washing.

● **Advice for the characteristics**

- In case that an optical filter is set in front of the emitter and detector portion, the optical filter which has the most efficient transmittance at the emitting wavelength range of LED for this product ($\lambda = 870 \pm 70\text{nm}$), shall be recommended to use. Both faces of the filter should be mirror polishing. Also, as there are cases that the characteristics may not be satisfied according to the distance between the protection cover and this product or the thickness of the protection cover, please use this product after confirming the operation sufficiently in actual application.
- In case that there is an object near to emitter side of the sensor between sensor and a detecting object, please use this device after confirming sufficiently that the characteristics of this sensor do not change by the object.
- When the detector is exposed to the direct light from the sun, tungsten lamp and so on, there are cases that it can not measure the distance exactly. Please consider the design that the detector is not exposed to the direct light from such light source.
- Distance to a mirror reflector can not be sometimes measured exactly. In case of changing the mounting angle of this product, it may measure the distance exactly.
- In case that reflective object has boundary line which material or color etc. are excessively different, in order to decrease deviation of measuring distance, it shall be recommended to set the sensor that the direction of boundary line and the line between emitter center and detector center are in parallel.

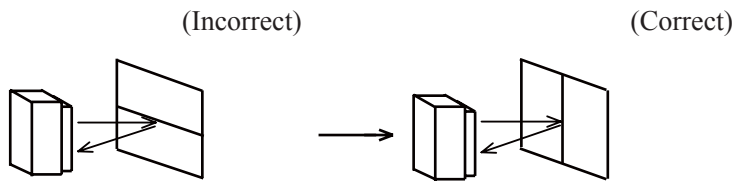

- In order to decrease deviation of measuring distance by moving direction of the reflective object, it shall be recommended to set the sensor that the moving direction of the object and the line between emitter center and detector center are vertical.

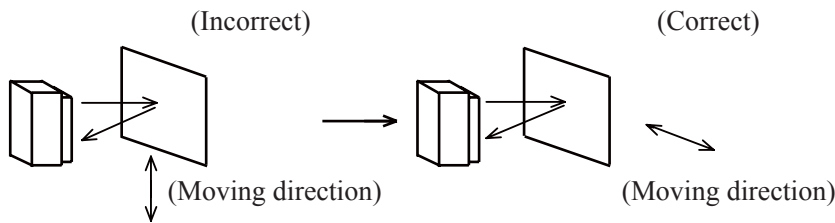

● **Advice for the power supply**

- In order to stabilize power supply line, we recommend to insert a by-pass capacitor of 10 μF or more between Vcc and GND near this product.

● **Notes on handling**

- There are some possibilities that the internal components in the sensor may be exposed to the excessive mechanical stress. Please be careful not to cause any excessive pressure on the sensor package and also on the PCB while assembling this product.

● Presence of ODC etc.

This product shall not contain the following materials.

And they are not used in the production process for this product.

Regulation substances : CFCs, Halon, Carbon tetrachloride, 1.1.1-Trichloroethane (Methylchloroform)

Specific brominated flame retardants such as the PBB and PBDE are not used in this product at all.

This product shall not contain the following materials banned in the RoHS Directive (2002/95/EC).

- Lead, Mercury, Cadmium, Hexavalent chromium, Polybrominated biphenyls (PBB), Polybrominated diphenyl ethers (PBDE).

■ Package specification

Package method

- MAX.50 pieces per tray
- MAX 500 pieces per case
- Arranges in 10 stages of trays containing products into the outer case.
- Put pads between trays.
- Closes the lid of case and seals with kraft tape..

Package composition

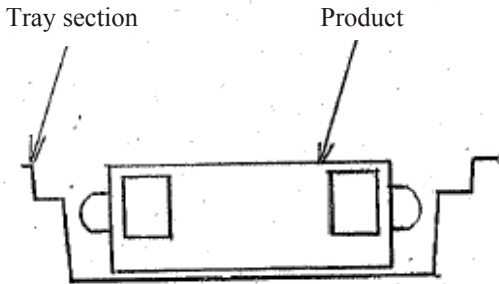
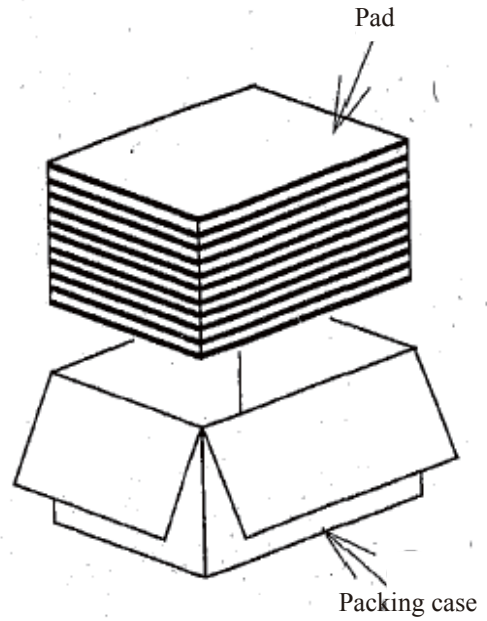
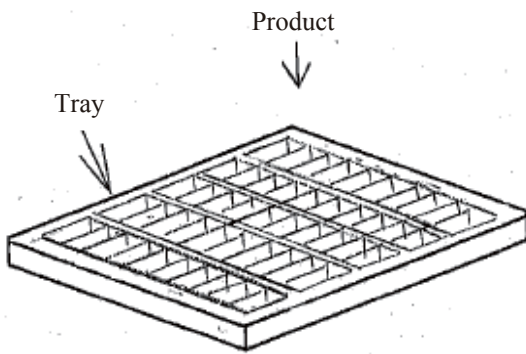

■ Important Notices

· The circuit application examples in this publication are provided to explain representative applications of SHARP devices and are not intended to guarantee any circuit design or license any intellectual property rights. SHARP takes no responsibility for any problems related to any intellectual property right of a third party resulting from the use of SHARP's devices.

· Contact SHARP in order to obtain the latest device specification sheets before using any SHARP device. SHARP reserves the right to make changes in the specifications, characteristics, data, materials, structure, and other contents described herein at any time without notice in order to improve design or reliability. Manufacturing locations are also subject to change without notice.

· Observe the following points when using any devices in this publication. SHARP takes no responsibility for damage caused by improper use of the devices which does not meet the conditions and absolute maximum ratings to be used specified in the relevant specification sheet nor meet the following conditions:

(i) The devices in this publication are designed for use in general electronic equipment designs such as:

- Personal computers
- Office automation equipment
- Telecommunication equipment [terminal]
- Test and measurement equipment
- Industrial control
- Audio visual equipment
- Consumer electronics

(ii) Measures such as fail-safe function and redundant design should be taken to ensure reliability and safety when SHARP devices are used for or in connection

with equipment that requires higher reliability such as:

- Transportation control and safety equipment (i.e., aircraft, trains, automobiles, etc.)
- Traffic signals
- Gas leakage sensor breakers
- Alarm equipment
- Various safety devices, etc.

(iii) SHARP devices shall not be used for or in connection with equipment that requires an extremely high level of reliability and safety such as:

- Space applications
- Telecommunication equipment [trunk lines]
- Nuclear power control equipment
- Medical and other life support equipment (e.g., scuba).

· If the SHARP devices listed in this publication fall within the scope of strategic products described in the Foreign Exchange and Foreign Trade Law of Japan, it is necessary to obtain approval to export such SHARP devices.

· This publication is the proprietary product of SHARP and is copyrighted, with all rights reserved. Under the copyright laws, no part of this publication may be reproduced or transmitted in any form or by any means, electronic or mechanical, for any purpose, in whole or in part, without the express written permission of SHARP. Express written permission is also required before any use of this publication may be made by a third party.

· Contact and consult with a SHARP representative if there are any questions about the contents of this publication.